

# Forcitta

Living in trend

## SPECS



**ELAN-40** / FRAME: Bent exterior steel frame covered w/fabric lined polyurethane foam. SEAT: Solid Birch paired w/cross-woven elastic webbing topped w/high-resilient polyurethane foam topped w/feather down. CUSHIONS: Back cushions filled w/channeled feather down w/high-resilient polyurethane foam core. C08B0204 filled w/feather down & polyester fiber. C08TYK01 filled w/feather down. FEET: inset black ABS plastic feet. TABLE: Free-floating Grey Oak veneered side table. UPHOLSTERY OPTIONS: Fabric (removable), Leather (non-removable) or fabric/leather combo.



**B12B0216 FEATURES:**

- Single drawer with interior tray
- Cable management channel at back
- Available in Grey Oak

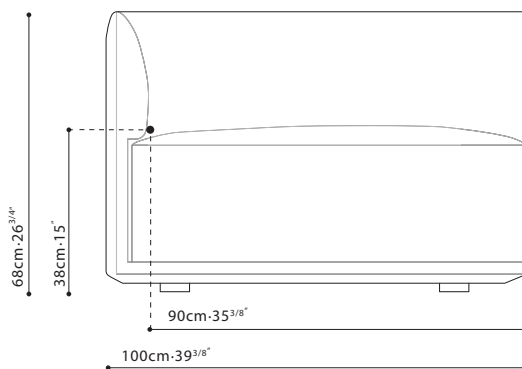

## FABRIC VERSION

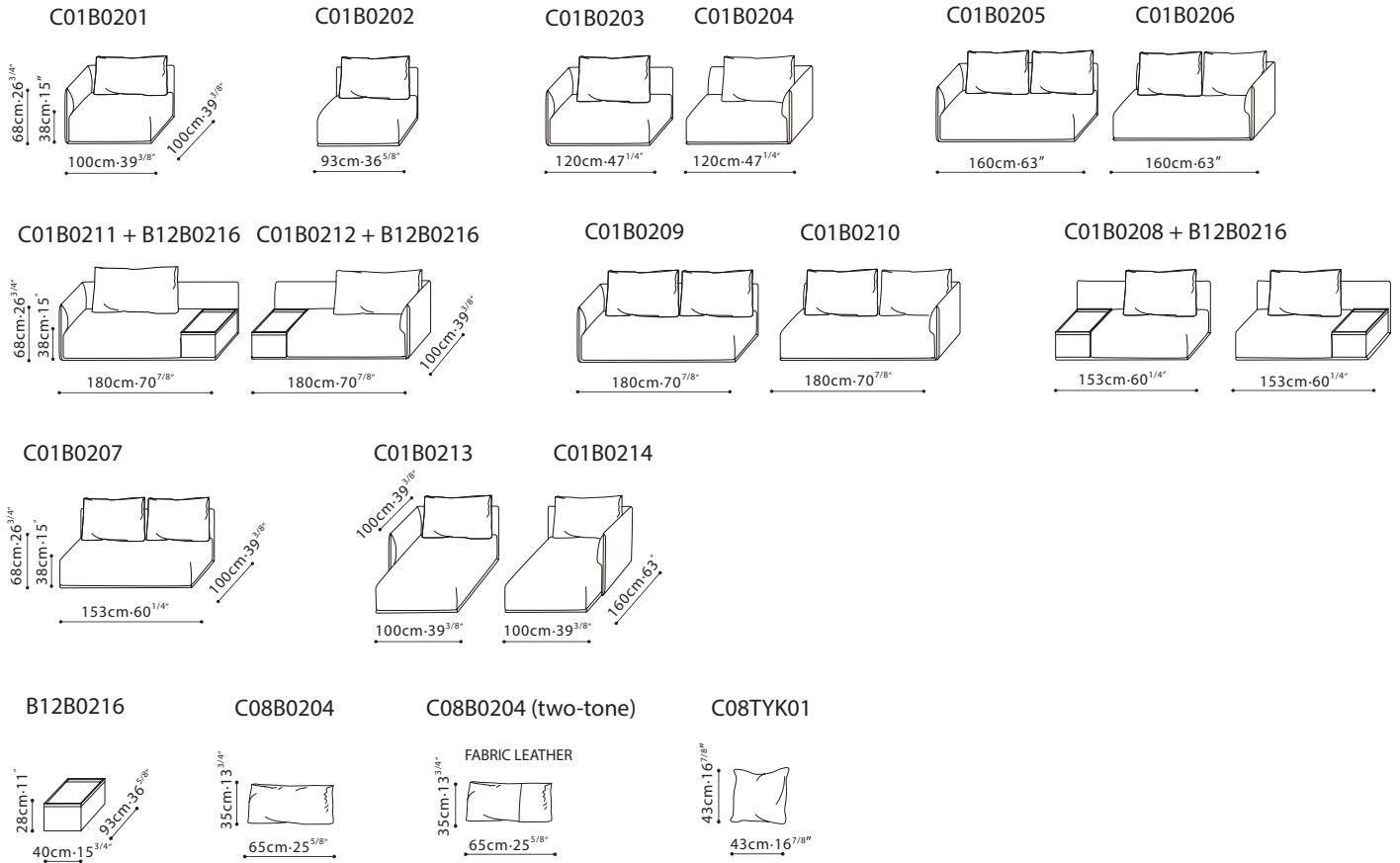

## LEATHER VERSION

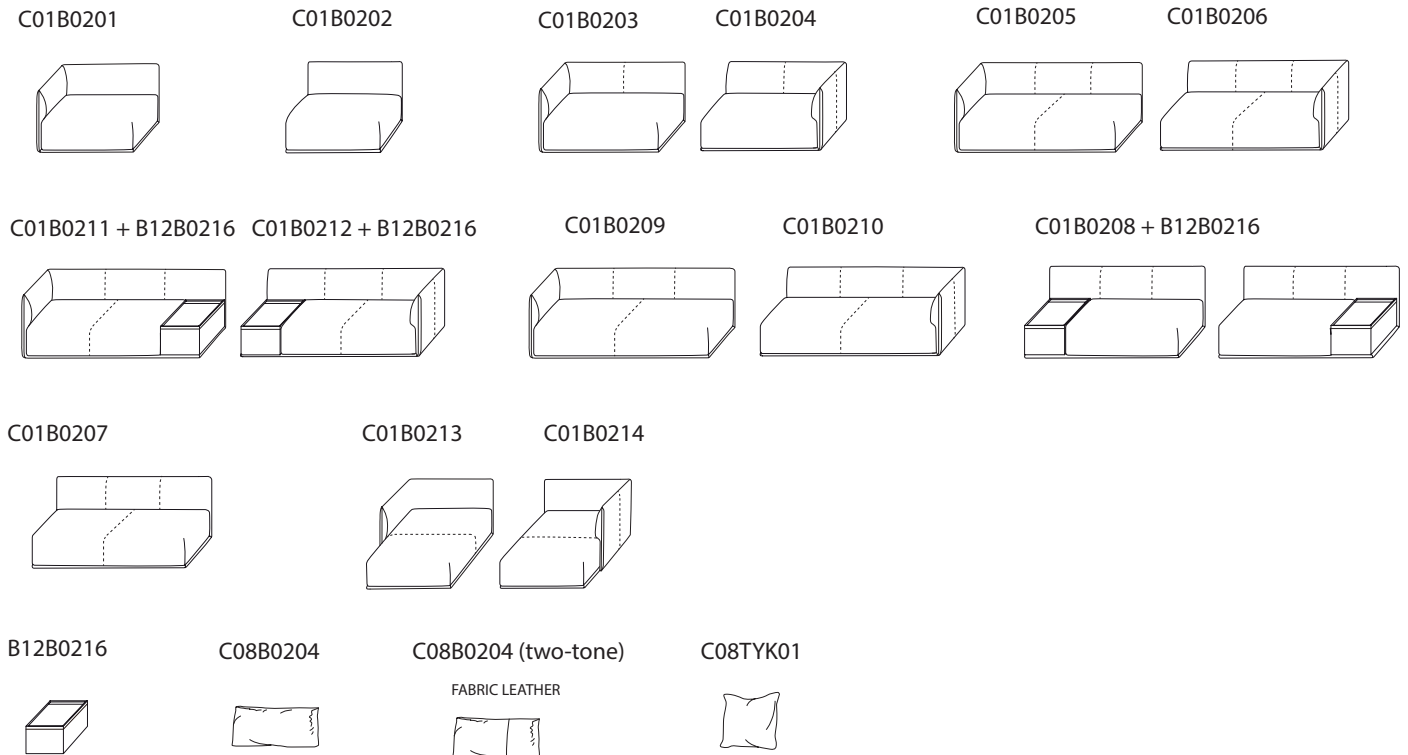

(dotted lines illustrate positioning of stitched seams on leather versions of this sofa)

## RECOMMENDED CUSHIONS

Item Code	
C01B0201	C08B0204*1, and C08TYK01*1
C01B0202	C08B0204*1
C01B0203/04	C08B0204*1, and C08TYK01*1
C01B0205/06	C08B0204*2, and C08TYK01*1
C01B0207	C08B0204*2
C01B0208	C08B0204*1
C01B0209/10	C08B0204*2, and C08TYK01*1
C01B0211/12	C08B0204*1, and C08TYK01*1
C01B0213/14	C08B0204*1, and C08TYK01*1

## SAMPLE CONFIGURATION

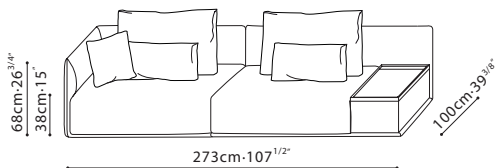

C01B0203+C01B0208+B12B0216+C08B0204×2+C08TYK01

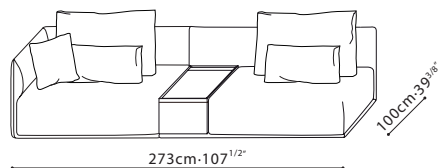

C01B0203+C01B0208+B12B0216+C08B0204×2+C08TYK01

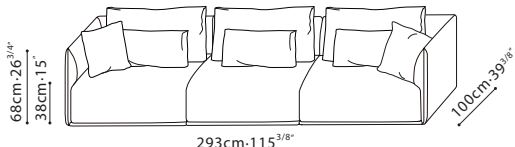

C01B0201+C01B0202+C01B0201+C08B0204×3+C08TYK01×2

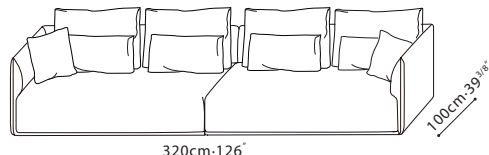

C01B0205+C01B0206+C08B0204×4+C08TYK01×2

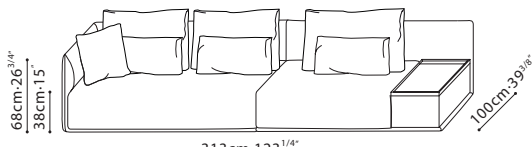

C01B0205+C01B0208+B12B0216+C08B0204×3+C08TYK01

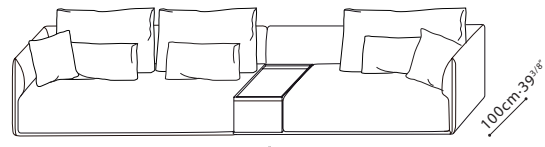

C01B0209+C01B0212+B12B0216+C08B0204×3+C08TYK01×2

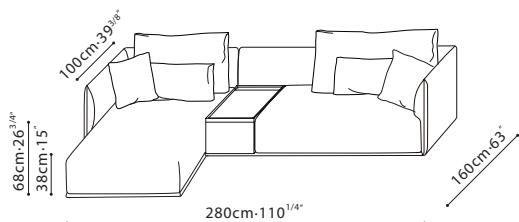

C01B0213+C01B0212+B12B0216+C08B0204×2+C08TYK01×2

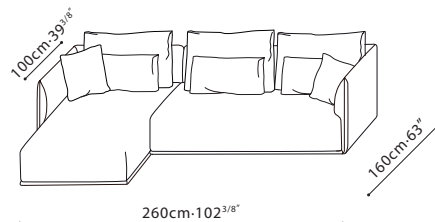

C01B0213+C01B0206+C08B0204×3+C08TYK01×2

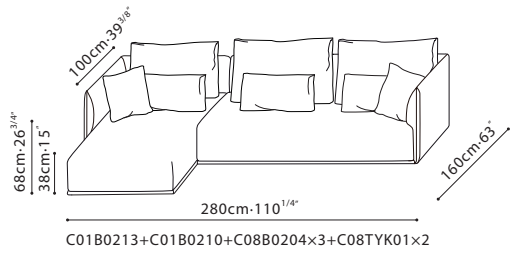

C01B0213+C01B0210+C08B0204×3+C08TYK01×2

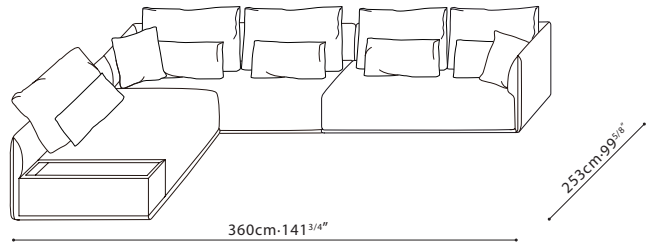

C01B0209+C01B0210+C01B0208+B12B0216+C08B0204×5+C08TYK01×2

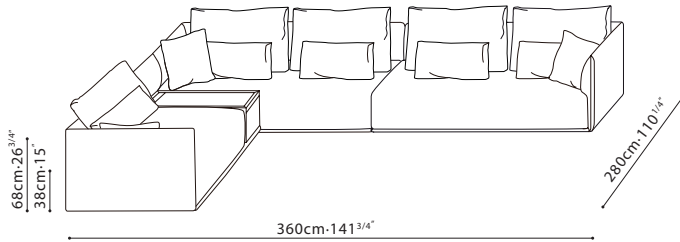

C01B0211+C01B0209+C01B0210+B12B0216+C08B0204×5+C08TYK01×3

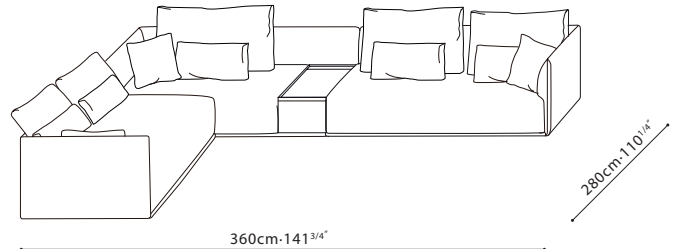

C01B0211+C01B0209+C01B0210+B12B0216+C08B0204×5+C08TYK01×3